

THE OLIVIER STREBELLE SCULPTURE IN BEIJING (CHINA)

Jean-Marc WEILL – C&E Ingénierie (France)

The purpose of the paper is to present the structural engineering design developed for the Olivier Strebelle Sculpture, so called the Athletes Alley, built in Beijing (China) for the Chinese Olympic Games in 2008. The Athletes Alley (100 meters long by 20 meters high), located in the western wing of the Olympic Parc, celebrates Beijing 2008 Olympic Games and is designed with five sculpture representing five Athletes holding up the Olympic rings. Given the unusual complexity of the structural behavior of each of the sculpture, we will develop through this paper the design process followed for the structural engineering analysis using Sophistic Software.

Summary:

- 1- Context.
- 2- Load hypothesis.
- 3- Materials – Sections - Assemblies
- 4- Structural analysis process
- 5- Example of analysis of sculpture 2 and 5
- 6- Closure

1 CONTEXT

1.1 Situation

The purpose of the paper is to present the structural engineering design developed to statically analyse the Olivier Strebelle Sculpture, so called the Athletes Alley, built in Beijing (China) for the Chinese Olympic Games in 2008.



Fig.1: Olivier Strebelle in his studio

The Athletes Alley (100 meters long by 20 meters high), located in the western wing of the Olympic Parc, celebrates Beijing 2008 Olympic Games and is designed with five sculpture representing five Athletes holding up the Olympic rings. The target of this artwork was to create an optical effect that changes as the visitors stroll along a path. At first sign the visitors perceive five 20-meter high stainless steel figures (varying from 8 to 20 meters high, around 15 meters long and 10 meter wide) displayed on both sides of a 100 meter long path. When they reach the focal point, situated in the axis of the path, the figures magically appear as five characters holding up the Olympic rings.

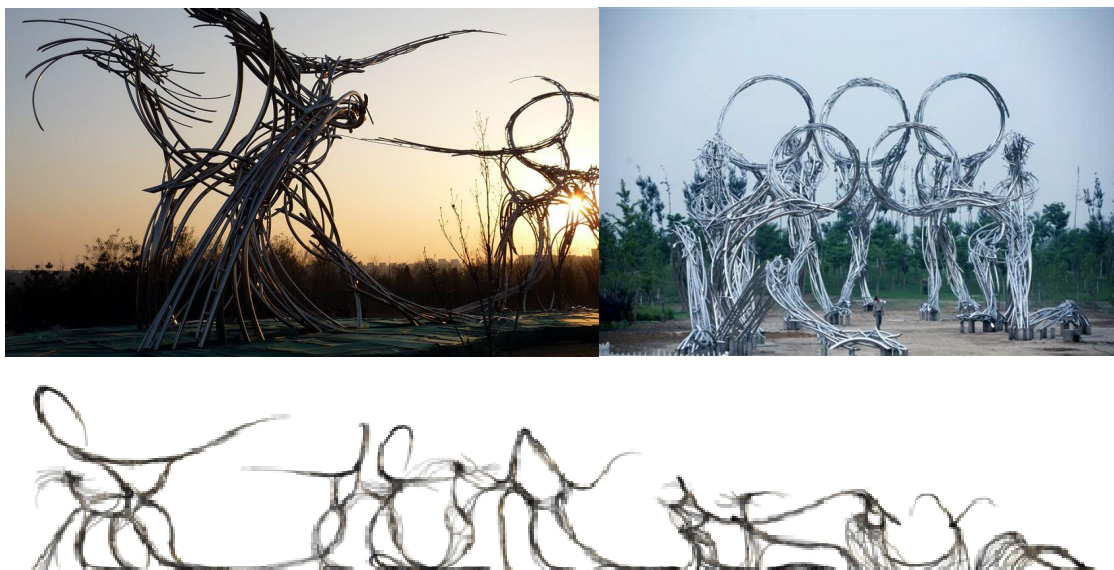

Fig.2: general overview of the 5 sculptures.

The five sculptures are built with 1500 steel hollow sections which are never crossing each other but are connected together to improve global beam behavior (trusses or vierendeels) without increasing the diameters of the tubes (around 4500 connexions are designed for the 5 sculptures).



Fig.3: connexions between tubes..

1.2 Elaboration of the design process

A basic and mainly physical procedure was proposed. For the first checking a simple elastic-elastic or elastic-plastic stress analysis for a few carefully selected design combinations was chosen. The 3rd order theory was used for calculation (fully geometrical non linear analysis). The use of the 3rd order theory is considered absolutely necessary because of the extremely slender structural characteristics which will certainly produce non linear effect (cable like).

The global stability check of the structure is performed as a stress problem. The structure is loaded with a characteristic load collective including possible imperfection. The calculation is performed as a load incremented stepwise calculation including fully geometric nonlinear effects and possibly also material non linear effect (stiffness reduction). This is considered as the basis on finite element analysis based design procedures, since classical stability assessments like buckling length fail for arbitrary complex structure. The purpose of this paper is to present the technical thinking which followed this unusual design.

2 LOADS HYPOTHESIS

2.1 Dead load

The dead load hypothesis are strictly the result of the circular hollow sections used to build the stainless steel structure.

2.2 Wind load

The wind load hypothesis were established crossing French and Chinese Codes regarding the uniqueness of the subject. The wind loads are applied on each pipe projected on a plan perpendicular to the wind direction. The main parameters used for calculation are the following:

- Exposure factor μ_s :

	Maximum height (m)	μ_s
Sculpture 1	10	1.00
Sculpture 2	11.5	1.14
Sculpture 3	14.5	1.14
Sculpture 4	16	1.25
Sculpture 5	19	1.25

- Shape factor $\mu_z=1.3$

- Dynamic wind effect β_z :

	Dynamic wind effect β_z :
Sculpture 1	1.94
Sculpture 2	1.90
Sculpture 3	1.90
Sculpture 4	1.83
Sculpture 5	1.83

- Basic wind pressure induced for each sculpture:

	Basic wind pressure (kN/m ²)
Sculpture 1	1.14
Sculpture 2	1.27
Sculpture 3	1.28
Sculpture 4	1.36
Sculpture 5	1.36

8 directions of wind have been considered in the FEM models:

LC2: Wind W2, direction global +YY - LC3: Wind W3, direction global -YY

LC4: Wind W4 direction global +XX - LC5: Wind W5 direction global -XX

LC6: Wind W6 direction oblique - LC7: Wind W7 direction oblique

LC8: Wind W8 direction oblique - LC9: Wind W9 direction oblique

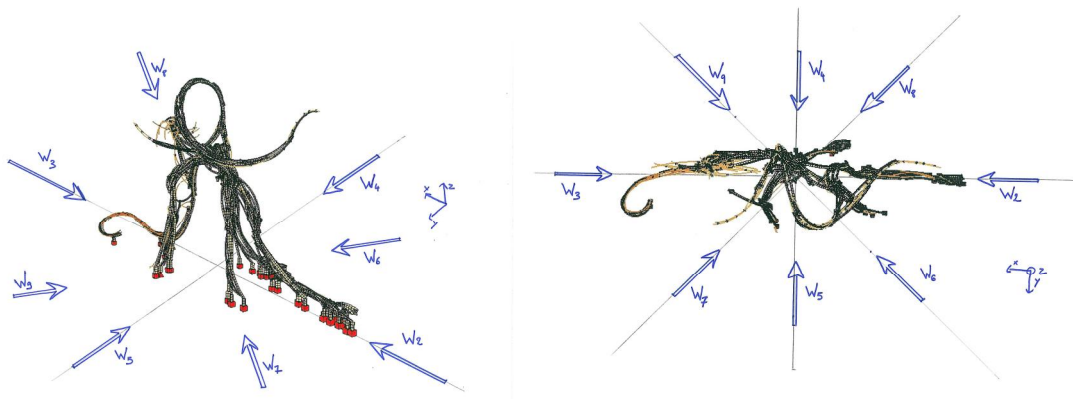

Fig.4: wind load typical directions

2.3 Snow load

The snow load hypothesis are as followed:

- The reference snow pressure is $s_0 = 0.40 \text{ kN/m}^2$
- The snow cover distribution is calculated by taking into account the shape of the hollow section and the slope of the arcs (by assimilation to an arched roof):

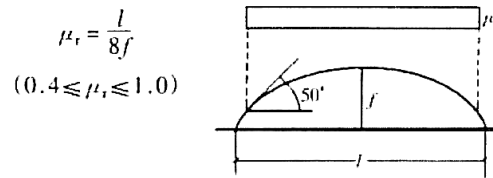

Fig.5: Cover distribution of a arched roof according To Chinese Code

$\alpha > 50^\circ$: $\mu_{r1} = 0$

$\alpha < 50^\circ$: $\mu_{r1} = D / (8(D/2)) = 0.25$. But μ_r mini = 0.4 thus $\mu_{r1} = 0.4$ (according to Chinese code)

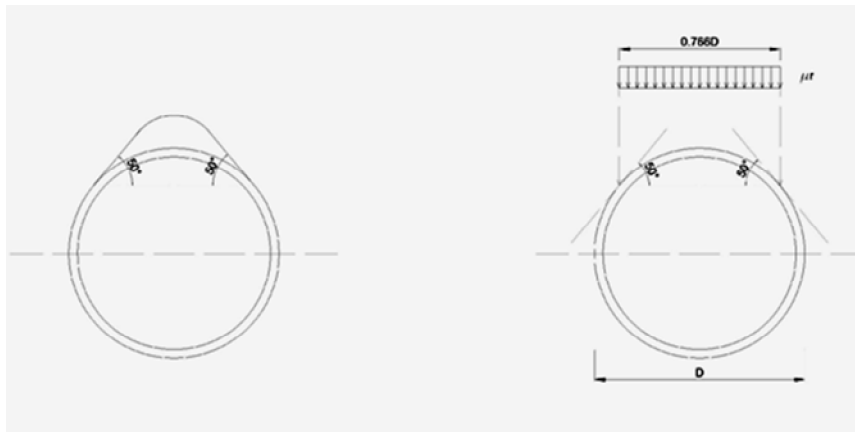
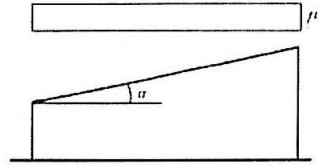

Fig.6: Principle of snow repartition on a tube

The roof comparison is conservative because the coefficient of friction between snow and polished stainless steel is lower than the one of a rough roof. Indeed, the angle α corresponding to the coefficient of friction between iced steel and snow is $\alpha=22^\circ$. In this case the snow would cover the tube on a distance of $0.355D$. In order to be on the safe side, we will take $\alpha=50^\circ$ and $0.766D$.

- Global snow cover distribution: This factor takes into account the global slope of the tube that received the snow. This factor is calculated following the Chinese code, by assimilation of a single span mono pitched roof. The mean inclination of all arcs is around 45° (statistic calculation), and the standard type deviation is around 5, thus we have taken a mean inclination of 40° , thus we have considered $\mu_{r2} = 0.4$

Single span
monopitched
roof



α	$\leq 25^\circ$	30°	35°	40°	45°	$\geq 50^\circ$
μ_r	1.0	0.8	0.6	0.4	0.2	0

Fig.7: Cover distribution of a single span mono pitched roof according to Chinese Code

The basic snow pressure induced for each sculpture that is to say the cover distribution factor is then: $\mu_r = 0.766D * \mu_{r1} * \mu_{r2}$: $\mu_r = 0.122D$ (with D as diameter of the circular hollow section).

2.4 Seismic load

The seismic load hypothesis is given from the response spectrum method used for modal analysis.

The main seismic data used for the model are the following:

- Design basic acceleration ground motion: 0.2g
- Damping ratio: 0.05

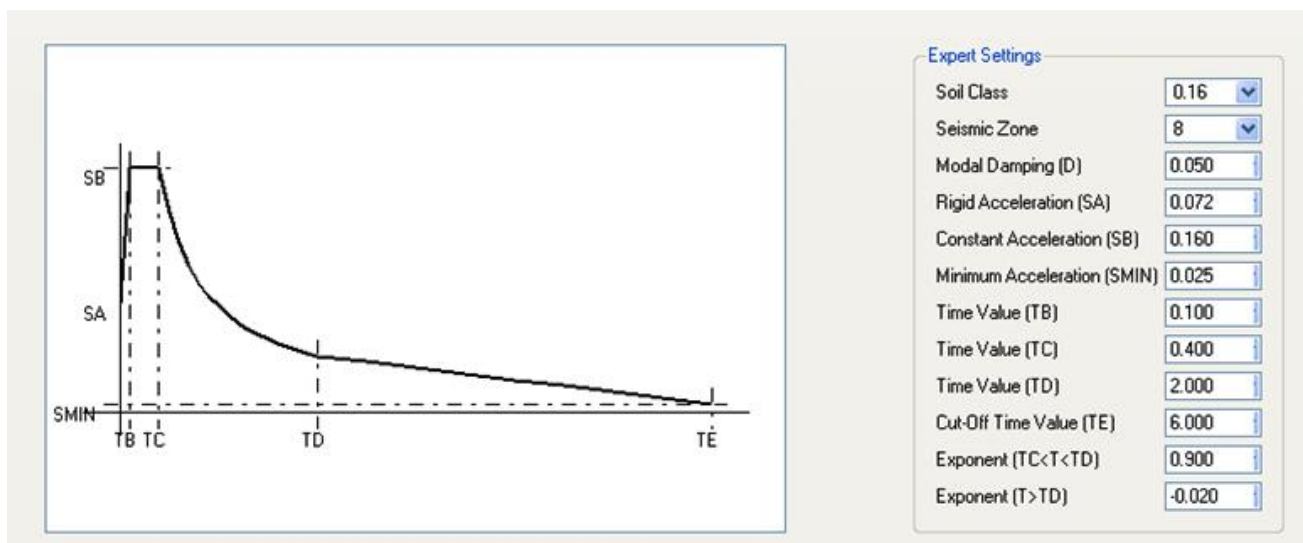

Fig.8: Response spectrum used for the seismic analysis

2.5 Temperature load

The temperature load hypothesis was checked with the following combination:

- 1.35G + 0.9T where T = +/- 25°C.

3 MATERIALS – SECTIONS - ASSEMBLIES

3.1 *Materials*

The material used for construction is stainless steel “304”. The properties are the following:

Longitudinal modulus of elasticity	E : 200 GPa
Transversal modulus of elasticity	G : 77 GPa
Steel density	ρ : 7 930 kg/m ³
Thermal expansion coefficient	λ : 12×10^{-6} m/m/°C
Conventional yield point	$f_y = 210$ Mpa

Because of the uncertainties of the local building context for such an unusual project, the design has been carried out with an additional safety factor of 1.1 applied directly to the stainless steel conventional limit stress. As a result the value considered for the structural design analysis is $f_y/1.1 = 210/1.1 = 190.9$ MPa

3.2 *Sections*

The circular hollow sections diameters used for the design are the following (with a thickness varying from 2.5 to 30 millimeters):

- Primary structural system:
D 89 mm / D 102 mm / D 114.3 mm / D 127 mm / D 159 mm
D 168 mm / D 219.1 mm
- Secondary structural system:
D 42.5 mm / D 60.3 mm / D 88.9 mm

3.3 *Assemblies*

The connections between arches are designed in order to transfer internal forces following two ways:

- Simple connection between arches to transfer loads.
- Connection between arches to create truss and vierendeel beams in complement with the arch action.

The effects of the assemblies' behaviour on the structural design of each sculpture are taken in account in the global analysis. All the connections are integrated in the model regarding the following rules:

- Hinged joint when the assembly does not transfer any bending moment.
- Fixed joint when the assembly transfers bending moment.

The relative position of any arch relatively to any other is tangent. Thus the connections are designed based following guidelines:

- When the relative distance between two arches is superior to 10 mm and inferior to 100 mm the connection is a cross made of two plates acting as a cross following the global geometry.
- When the relative distance between two arches is superior to the 100 mm the connection is done with a circular hollow section welded between the sections.
- When the connection between two arches is a hinged the connection is made of a circular hollow section welded on one edge and hinged on the other edge.



Fig.9: Construction process and on site assemblies

4 STRUCTURAL ANALYSIS PROCESS

4.1 Overview

The global design and analysis process of the stability of the sculptures contains:

A global non linear static analysis:

- Full Newton Raphson iterations analysis with non Linear Geometry: Large Displacement with 3rd order theory
- Design according elastic limit ($f_y/1.1$)

Two complementary buckling analysis:

- Linear Buckling Analysis.
- Determination of the Buckling Eigenvalues (Incremental Newton Raphson with imperfection and Determination of the Ultimate Load Factor).

A global dynamic analysis:

- Modal Dynamic Analysis: Determination of the Dynamic Eigenvalues
- Earthquake design according Chinese Code

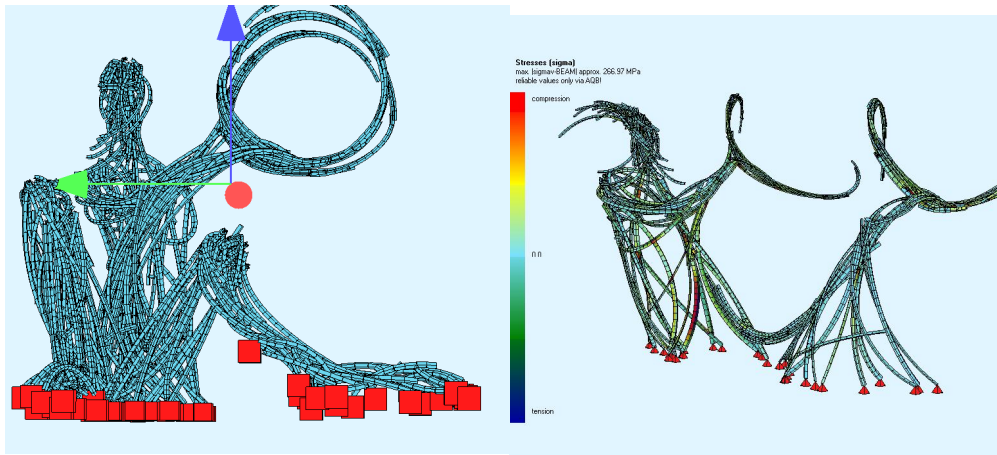

Fig.10: Modelisation of the sculpture under Sofistik software

4.2 Calculation methodology detail

Giving the unusual complexity of the structural behavior of each of the five sculptures, we have chosen to develop the analysis regarding the following process:

First step: the global stability has been checking following the third order analysis (large displacements) as follow:

- Convergence of a non linear analysis at ultimate state limit, serviceability state limit and linear material.
- Calculation of maximum stresses with a limit stress corresponding to 90 percents of the allowed elastic limit.
- Checking of displacement under dead load in particular.

Second step: The results are confirmed with the following methods:

- Computation of an ultimate load factor with non linear material increasing artificially the loads applied to the model. The ultimate load factor has to be coherent with the safety factors used for the third order analysis.
- Computation of a safety factor in relation with the Euler Buckling theory analysis.

4.3 Convergence of a non linear analysis under combined static loads

The calculation has been carried out with the third order theory and combined load cases, ultimate state limit and service state limit. The third order theory allows integrating large displacements and then was used to control the global deformation of the five structures. The objective of the design process is to keep all stresses under the elastic limit, thus the calculation of the third order theory has been carried out with a linear law of behavior of the material.

The convergence of the model calculated with the third order theory take in charge the verification of an equivalent buckling effect. Nevertheless, in order to confirm the resistance to global buckling of the structures, two calculations have been handled in parallel: calculation of buckling eigenvalues

(regarding the uniqueness of the geometry of each sculpture, the modal analysis is giving local values of frequencies rather than global ones) and calculation of an ultimate load factor coefficient.

4.4 *Checking of stresses*

The checking of stress is done as followed:

- The calculation of stresses has been carried out with combined loads at ultimate state limit.
- The limit of stresses considered is the elastic limit of the material divided by a additional safety factor chosen equal to 1.1: $f_{ye} = 210/1.1 = 190.9 \text{ MPa}$
- The results are presented on the shape of a quotient of the maximum stress on the section by the modified elastic limit of the material (Utilization Factor): $UF = \text{max stress} / f_{ye}$

4.5 *Checking of displacements*

Deflection under dead load is limited to maintain the shape of the sculpture from the focal point of view.

4.6 *Global buckling analysis*

As the convergence of the non linear calculation take in charge the non-buckling of the sculpture, the buckling liability of the sculpture has been handed (third order analysis). Nevertheless, in order to confirm the non linear analysis by studying specifically the buckling effect, we have carried two additional verifications using the elastic and non elastic properties of the material:

- Computation of an ultimate load factor: the calculation of an ultimate load factor is found while increasing homogeneously dead and wind load with a chosen imperfection. The software iterates this load case with non linear geometrical analysis and non linear material. The coefficient resulting is the coefficient multiplying the load case to get instability of the sculpture. This coefficient is superior to the code safety factors.
- Computation of buckling eigenvalues: the calculation of buckling eigenvalues considers deflected situation as imperfection and linear material. The eigenvalue obtained corresponds to a safety factor. We are supposing that it has to be superior to 5.

5 EXAMPLE OF ANALYSIS OF SCULPTURE 2 AND 5

5.1 *Sculpture 2*

The sculpture 2 is the second from the front, viewed from the focal point, and has a maximum height of 11.5meters. The sculpture 2 represents a kneeling athlete supporting the bottom right Olympic Ring.

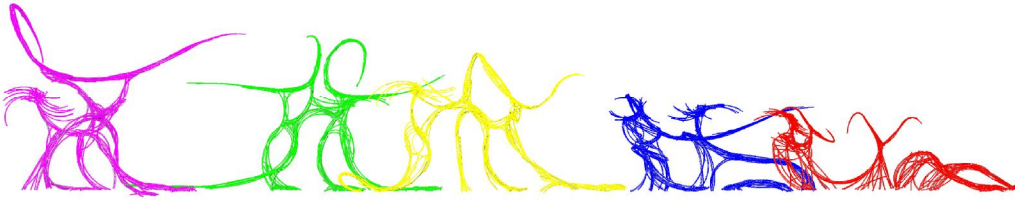

Sculpture 2

	Maximum height (m)	Approx. length(m)	Approx. width (m)	Approx. weight of arcs (tons)
Sculpture 2	11.5	20	9.4	13.5

- Total length of the circular hollow sections used : 1 044m
- Total number of connections between the hollow sections: 470
- Total number of connection to the ground: 55.

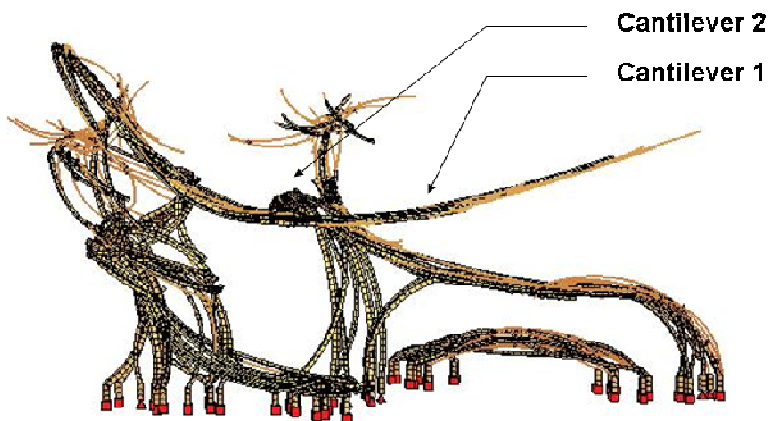
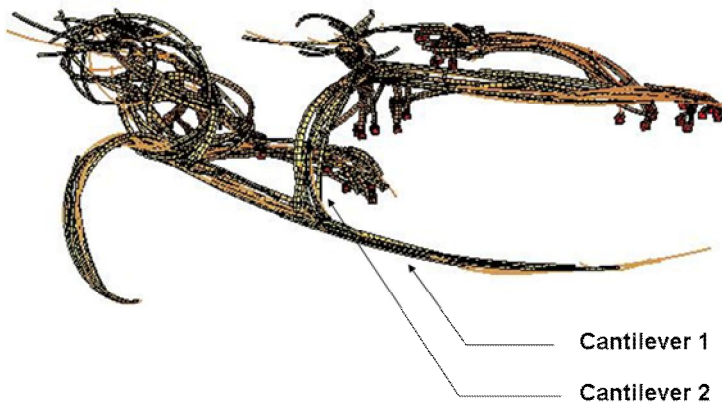

Fig.11: Modelisation of the sculpture under Sofistik software

From a static point of view the sculpture is designed as followed:

- The design is organized to produce one statically continuous element.
- The connections between the hollow sections are done to improve global beam action without increasing the diameters of the tubes. Their goal is to create truss or vierendeel beam actions. On

the other hand regarding their own rigidity they are participating to the load transfer design to the foundations.

- The front part of the sculpture is representing the left leg of the athlete and is acting as a truss with an arch effect. On his top a mast type trussed beam holds the cantilever ring.

- The rear part, representing the right leg and body of the athlete is acting as a multiple fixed supported mast.

- These two parts are joined to hold a long approximate helicoidally cantilevered trussed beam representing the ring.

- The critical design points is the following: the addition and directions cantilevers: the length of the cantilevered beam representing the ring, and its position swerved from its vertical support.

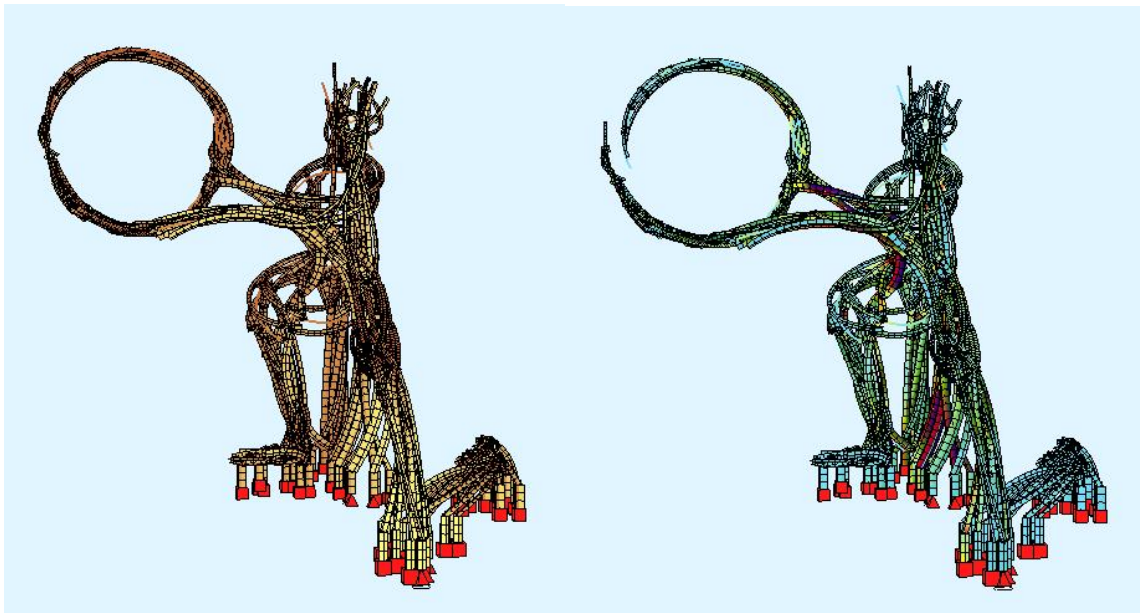

Fig.12: Modelisation of the sculpture under Sofistik software visualization of the deflection

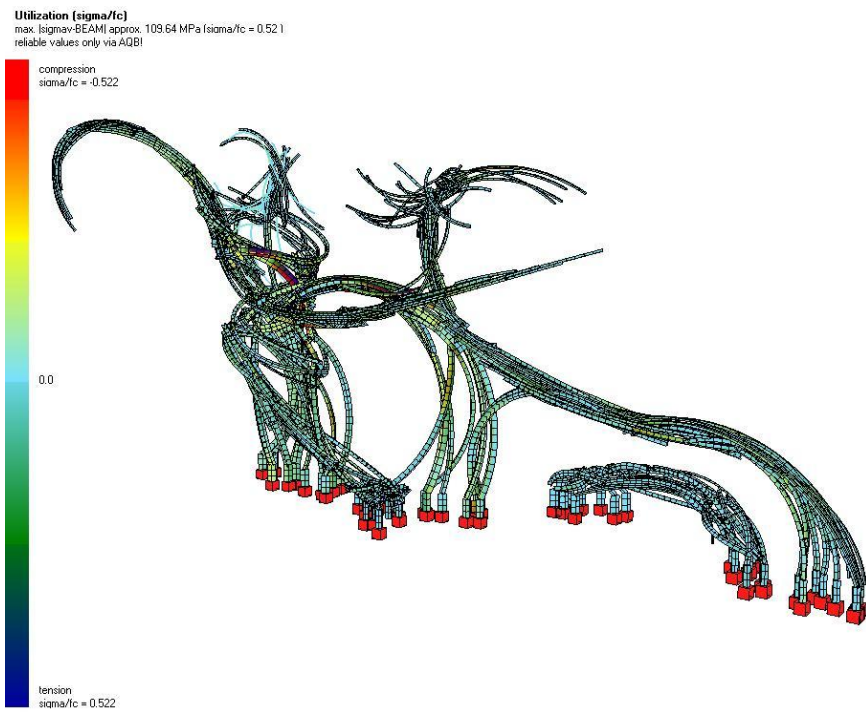
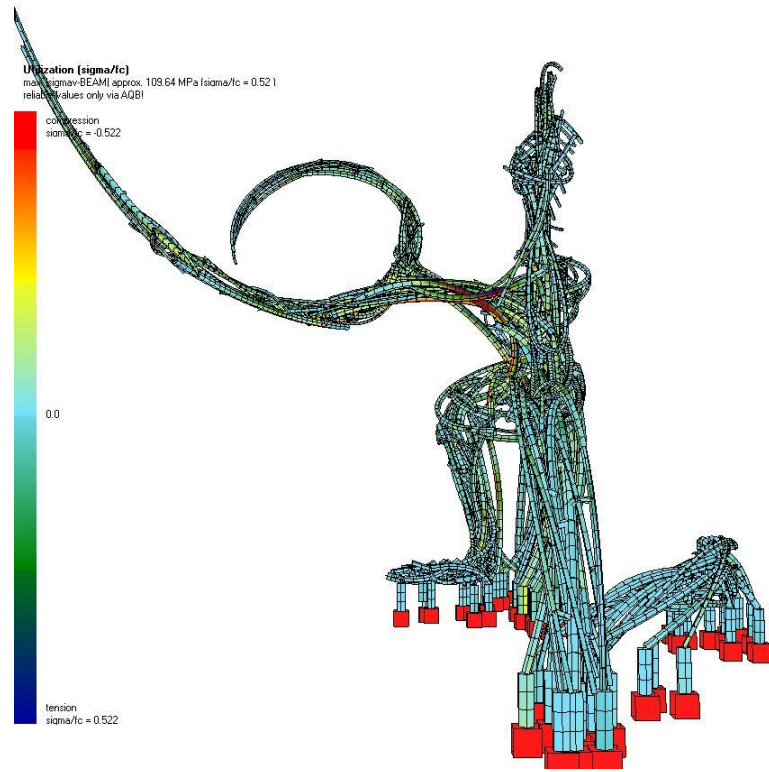
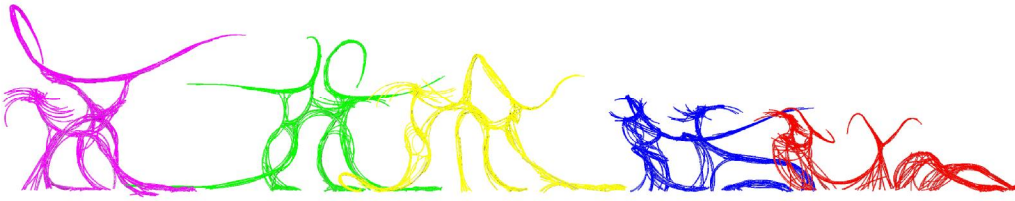

Fig.13: Modelisation of the sculpture under Sofistik

5.2 Sculpture 5

The sculpture 5 is the last one from the front, viewed from the focal point, and has a maximum height of 19 meters. The sculpture 3 represents a standing up athlete supporting the top left Olympic Ring.



Sculpture 5

	Maximum height (m)	Approx. length(m)	Approx. width (m)	Approx. weight of archs (tons)
Sculpture 5	19	24	10.9	35

- Total length of the circular hollow sections used : 1 234m
- Total number of connections between the hollow sections: 602
- Total number of connection to the ground: 42.

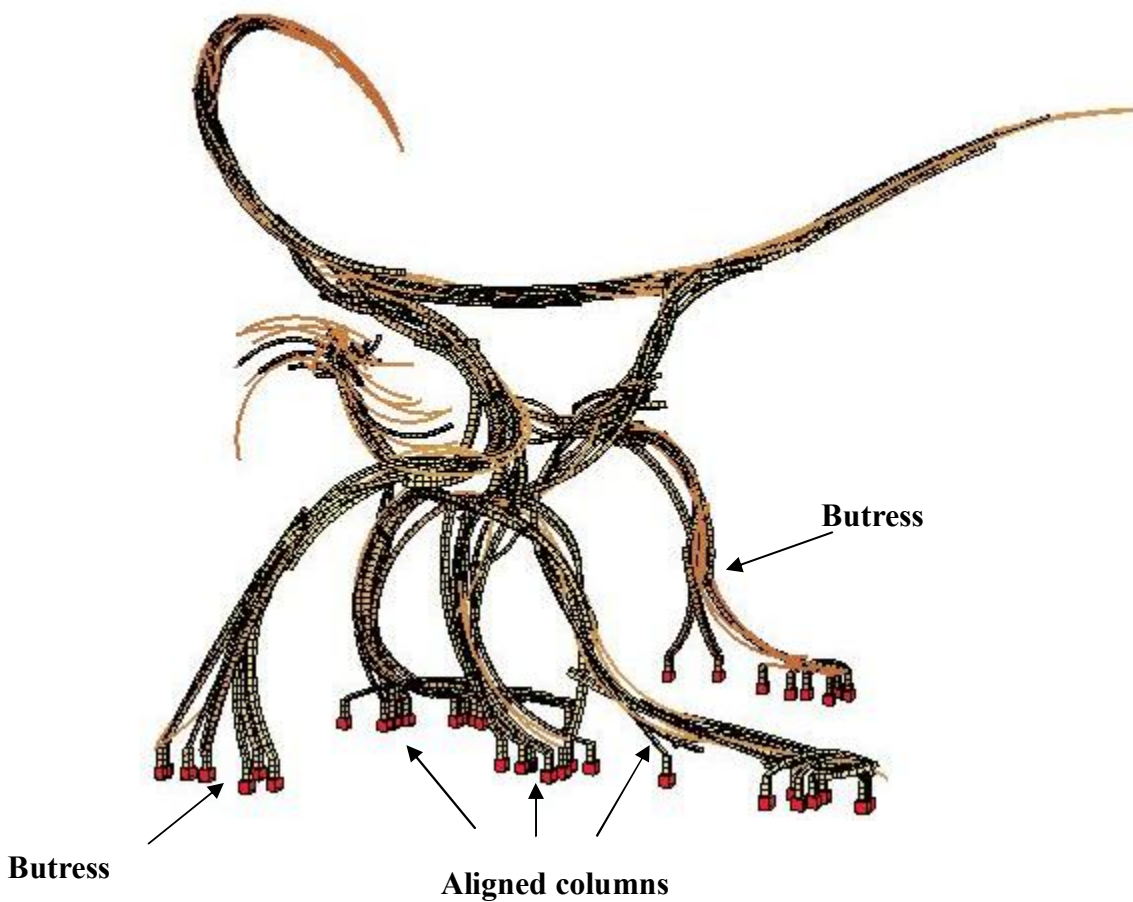

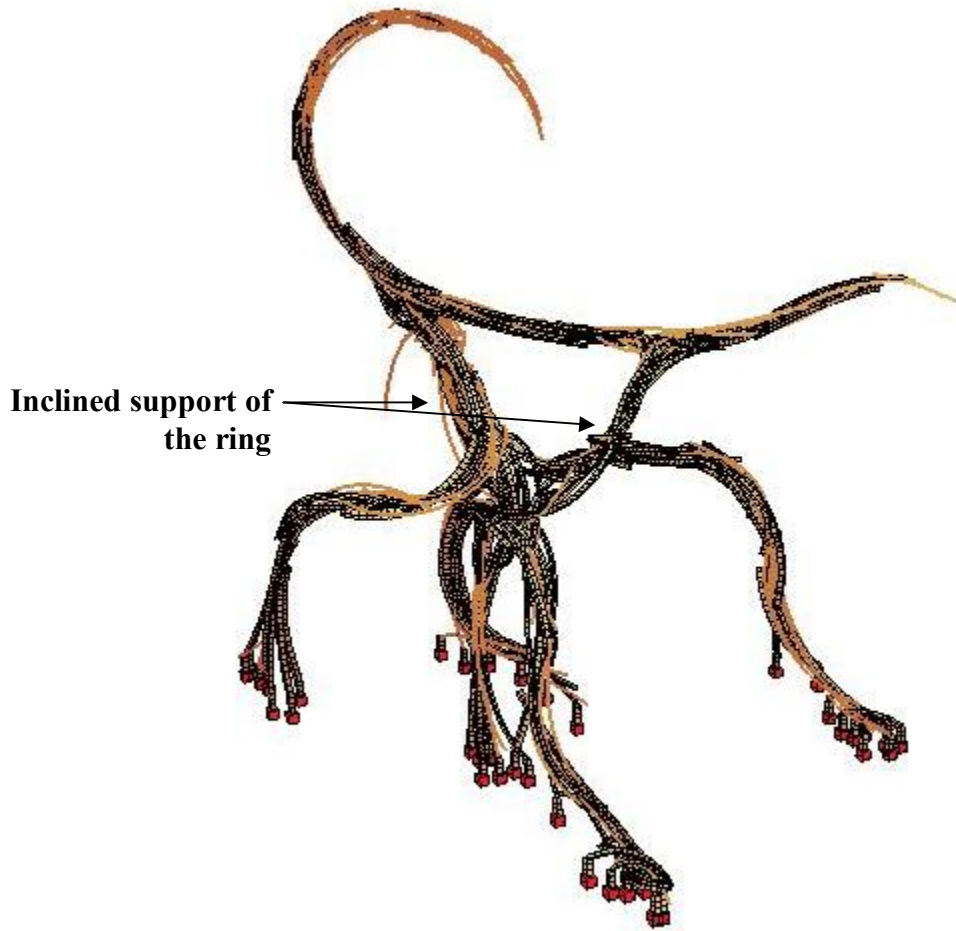
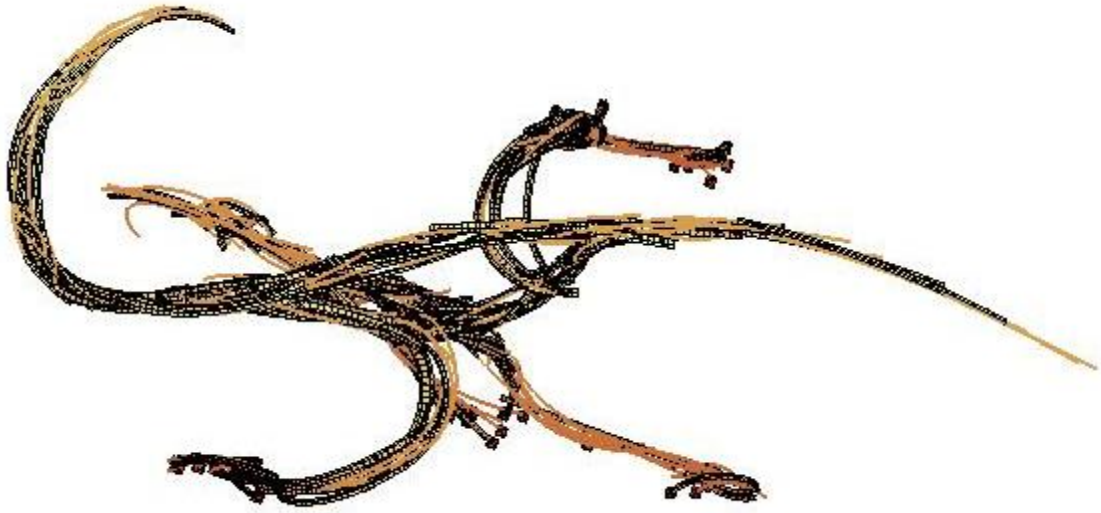

Fig.14: Modelisation of the sculpture under Sofistik

From a static point of view the sculpture is designed as followed:

- It is made of one statically continuous element.
- The connections between the hollow sections are done to improve global beam action without increasing the diameters of the tubes. Their goal is to create truss or vierendeel beam actions. On the other hand regarding their own rigidity they are participating to the load transfer design to the foundations.
- The sculpture is designed with 5 columns acting as complex trusses. 3 (out of 5) of these columns are representing the 2 legs of the athletes, and are located in the same plan. 2 (out of 5) of these columns are acting as transversal buttresses and are hidden behind the sculpture 3 and 4 on the focal image of the athlete.
- These columns are connected one to each other at the height of 13 m through transverses and longitudinal vaults.
- On top of two of these vaults 2 continuing trussed inclined beams representing the arms supports the long cantilever trussed beam representing the ring.

On top of one the rear column a mast supports arcs representing the head of the athlete.

The critical design points are the following: generally speaking: the large dimensions of the sculpture, the dimensions and length of the ring, the inclination of the arms, the connections between buttresses and transverse vaults, the connections between these vaults and the body.

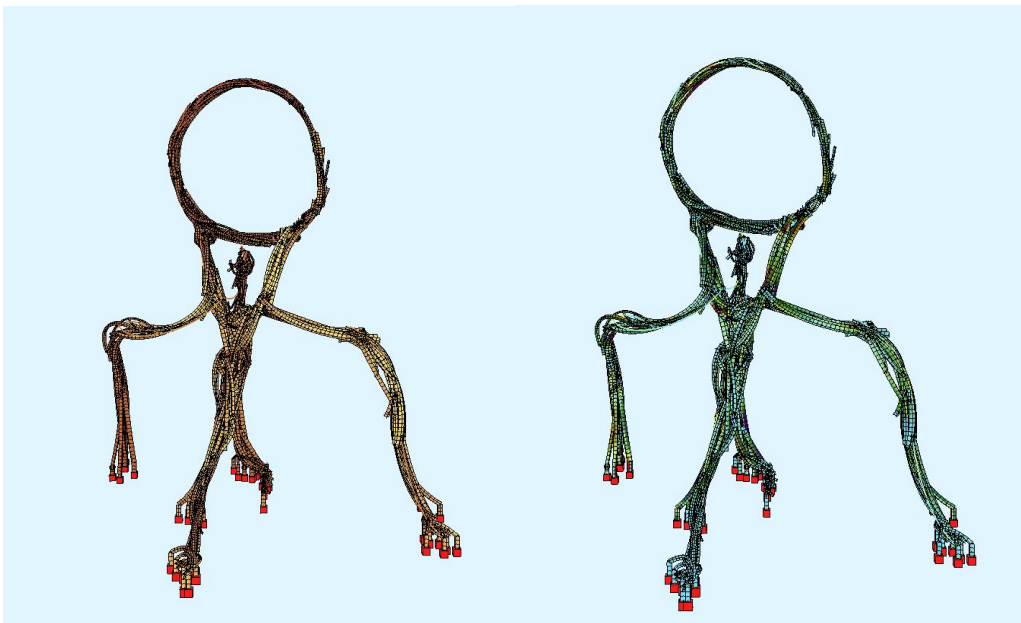

Fig.15: Modelisation of the sculpture under Sofistik software visualization of the deflection

6 CLOSURE

In this project calculation is becoming a promenade through force fields. No technical solution can be approved as totally exhaustive for each of the five structure. The terms are a very mixed group of constraints, materials and project forms, as well as tools used for the analysis.

The design stages used to organize the working process involve problem solving. The nature of underlying tasks is different for each stage, however, resulting in different appropriate methods of inquiry: Conceptual design is creative in relation with the artist (“what if?”). Design development involves solving a more structured set of problems and requires the coordinated effort of different areas of expertise (modelisation through Sofistik).

There is a natural flow from conceptual design to design development that suggests a build-up of increasingly restrictive constraints imposed by the relations among the stages. Structural engineering help to analyse different design alternatives and act as internal constraints throughout the design process. Structures should always be adapted to their environmental setting.

Olivier Strebelle’s art work analysis is a radical rather than non conventional exemple of this approach.



Fig.16: Final construction stage of the sculpture

7 BIBLIOGRAPHY

- [1] V.PAPANEK, “*Design for the Real World*”, Van Nostrand Reinhold, New York, N.Y., 1984.
- [2] Mc CARTHY, “*Situations, Actions, and causal laws*”, Stanford Artificial Intelligent Project, Memo No. 2.
- [3] C.LAPEYRE, “*Cours de Construction Métallique pour le Bâtiment*”, E.S.I.T.C, 1999.
- [4] S.N. POLLALIS, “*A framework for the design process*”, Harvard University